

## **Design, Simulation And Performance Evaluation Of 4x4 MIMO System Using Beamforming Techniques.**

Neha Bajpai, Neeraj Shrivastava

*Dept. of Electronics Engineering, RJIT, Gwalior*  
*Corresponding Author: Neha Bajpai*

---

**Abstract:** *This paper presents the capacity performance by various beamforming techniques for wireless communication systems. Multiple antennas structures can be classified into single input single output (SISO), single-input multiple-outputs (SIMO), multiple-inputs single output (MISO), and multiple-inputs multiple-outputs (MIMO) systems. Result shows that enhancing of MIMO's channel capacity for different beamforming techniques.*

**Keywords:** *MIMO Channels; MIMO Systems; Capacity; SISO; SIMO; MISO; SNR.*

---

Date of Submission: 01-03-2019

Date of acceptance: 18-03-2019

---

### **I. Introduction**

“Capacity enhancement of MIMO system under different fading channels”. In this research paper, the Rayleigh fading on the transmitted signal in the MIMO system is undertaken beneath various modulation technique and a model is considered to increase the channel capacity of the practical MIMO system in a fading environment. And after that, it is observed that the channel capacity of MIMO system depends upon SNR of the transmitted signal and number of antenna elements in an antenna array. And by increasing half wave dipoles in antenna array linearly increases the channel capacity. Binary phase shift keying modulation technique comes out to be more efficient in Rayleigh. Among Rayleigh, Gaussian and AWGN channel, Rayleigh is the worst case fading. Hence multiple antenna increase channel capacity presented in [1]

“Performance Evaluation of Channel Capacity In MIMO System”. In this research, the capacity of MIMO fading channel under Rayleigh environment has been investigated. These analyses show that the channel capacity depends on the accuracy of the channel estimation, and signal-to-noise ratio. This paper introduced the study of a MIMO system with partial or imperfect CSI at the transmitter has been presented for the MIMO capacity for spatial channel model with partial CSI knowledge. And this presented a general framework based on the replica method to discuss the impact of imperfect channel estimation error on multi-user channel capacity. So that increasing signal-to-noise ratio is helpful to improve the capacity. The imperfect channel state information decreases the channel capacity of multi-user MIMO channel when system capacity and signal-to-noise ratio are specified. Hence when the variance value of channel estimation error increases, the efficient transmitting rate of the system is attenuated. Where the degree of capacity loss due to imperfect channel state information is obtained. So that the water filling algorithm not only determines the maximizing sum capacity value but also the adaptive transmit policies that achieve optimum. presented in [2]

“Capacity and Performance of MIMO systems for Wireless Communications”. This paper provides the effect of using multiple antennas on the capacity of wireless communication systems by using Matlab codes. So that the results generated show the relationship between Number of antenna and capacity; our results show that increasing the number of transmitting and receiving antennas for a wireless MIMO channel does indeed improve the channel capacity and performance that can be obtained presented in [3]

“Design, Simulation and Performance Evaluation of 4 x 4 MIMO Transceiver System using 16 QAM”. This paper presents the MIMO-OFDM, MIMO techniques like space-time block code and spatial multiplexing. In this research, a real-time audio input a spatially multiplexed 4 x 4 MIMO OFDM transceiver using QAM is designed and implemented on Matlab Simulink. Thus MIMO transmits four data streams through a single channel, thereby can deliver four or more times the data rate per channel without additional bandwidth or transmit power presented in [4]

“Study and Analysis Capacity of MIMO Systems for AWGN Channel Model Scenarios”. In this paper the capacity increases linearly with the number of antennas for the case of additive white Gaussian noise channel and the performance of water filling is much better than the equal power allocation scheme for low SNR value and this gap can be minimized; if SNR increases. Hence it can be clearly stated that the power division concept as per the WF model for a MIMO channel significantly increases system efficiency than a

normal case and hence it could be a novel approach to look at the system for better results in a MIMO environment presented in [5]

In this paper, the channel capacity of MIMO is enhanced by different beamforming techniques such as Bartlett beamforming, Taylor window beamforming.

In section (II), define the system model in which all the systems like SISO, SIMO, MISO, MIMO are to be defined. In section (III), describe the mathematical model and types of a MIMO system and Beamforming techniques. In section (IV), the results are explained which is obtained by beamforming techniques. And the simulation result which is obtained by the various MATLAB codes are explained. In section (V) Conclusion.

## II. System Model

### SISO SYSTEMS

SISO stands for single input, single output refers to a wireless communications system in which one antenna is used at the source i.e transmitter and one antenna is used at the destination i.e receiver. SISO is the simplest antenna technology. When an EM field (electromagnetic field) is met with obstructions such as hills, canyons, buildings, and utility wires, the wavefronts are scattered, and thus they take many paths to reach the destination. Where the late arrival of scattered portions of the signal causes problems such as fading, cut-out (cliff effect), and intermittent reception (picket fencing). In the digital communications system, it can cause a reduction in data speed and an increase in the number of errors. Hence Capacity of such systems is given by Shannon capacity theorem giving the mathematical form as

$$C=B*\log_2 (1+SNR) \text{ bit/s}.....(1)$$

Where,

B= bandwidth of the systems, C= capacity, SNR is the signal to noise ratio.

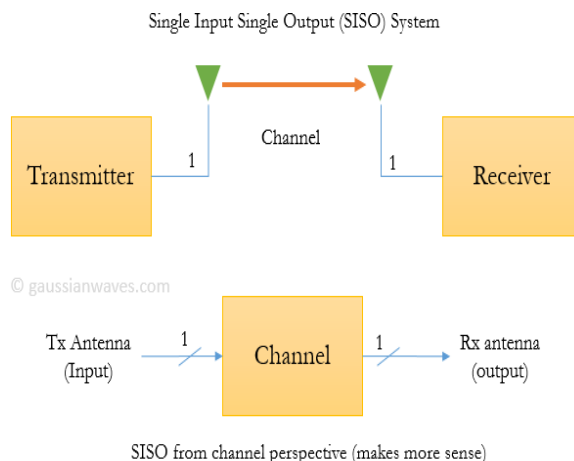

### SISO communication system

### SIMO SYSTEM

The SIMO or Single Input Multiple Output version of MIMO occurs where the transmitter has a single antenna and the receiver has multiple antennas. This is also known as receive diversity. It is also used to enable a receiver system that receives signals from a number of independent sources to combat the effects of fading. And also it has been used for many years with short wave listening / receiving stations to combat the effects of ionosphere fading and interference.

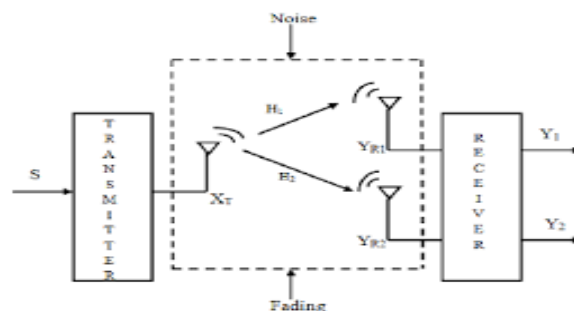

### SIMO communication system

**MISO SYSTEM**

MISO is also termed transmit diversity. In this system, the same data is transmitted redundantly from the two transmitter antennas. The destination end or receiver is then able to receive the optimum signal which it can then use to receive extract the required data. This is a scheme of radio frequency wireless communication system in which there are multiple transmitting antennas at the source and single receiving antenna at the system like SIMO but at the destination, a receiver has a single antenna [6]. The various applications of this scheme like in Digital television, W-lans. These systems are advantageous because the redundancy and coding have been shifted from receiving end towards the transmitting end and hence say in examples of mobile phones, less power, and processing is required at the user end or the receiver end[7]. The capacity of MISO and SIMO systems can be expressed as

$$C=B*\log_2 (1+nSNR) \text{ bit/s}.....(2)$$

Where n= number of transmit antenna in case of MISO systems and no. of receive antenna in case of SIMO systems.

SNR= Signal to noise ratio, C= Capacity of the system, and B= Bandwidth of the system.

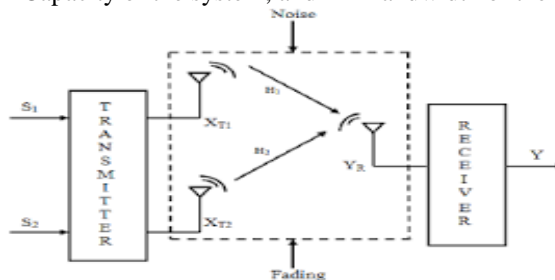

MISO communication system

**III. MIMO System**

Where there is more than one antenna at either end of the radio link, this is termed MIMO - Multiple Input Multiple Output. This system can be used to provide improvements in both channel robustness as well as channel throughput. So that in order to be able to benefit from MIMO fully it is necessary to be able to utilize coding on the channels to separate the data from the different paths. This system requires processing but provides additional channel robustness/data throughput capacity. By using Multiple Input Multiple Output, these additional paths can be used to advantage. These additional paths can be used to provide additional robustness to the radio link by improving the signal to noise ratio, or by increasing the link data capacity [8]. The capacity of the MIMO systems is given by the relation

$$C=B*\log_2 (1+n_T.n_R.S/R) \text{ bit/s}.....(3)$$

Where, n<sub>T</sub>= transmitter antenna,

n<sub>R</sub>= receiver antenna.

But, with the signal is coded using techniques called space-time coding

$$C=\min(n_T,n_R)*B*\log_2(1+SNR) \text{ bit/s}.....(4)$$

Where, Min (n<sub>T</sub>, n<sub>R</sub>) = minimum of n<sub>T</sub> and n<sub>R</sub> [9] [10][11]

Multiple Input Multiple Output systems often employ Spatial Multiplexing which enables signal to be transmitted across different spatial domains. Multiple Input Multiple Output is a hot topic in today wireless communications since all wireless technologies like PAN, LAN, MAN, and WAN trying to add it to increase the data rate multiple times which is used to satisfy their bandwidth-hungry broadband users.

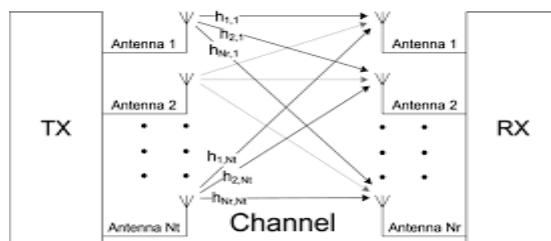

MIMO communication system

**A. Description:**

The input output relation for N transmitter antennas and M receiver antennas MIMO system is given by

$$y = Hx + n..... (5)$$

Where x = [x1, x2, ..., xN]



arrays intensify spatial multiplexing using narrow beams. These smart antennas belongs to adaptive antenna arrays, but differs in their estimation of smart direction of arrival. The beam forming is a technique used to form the radiation pattern of an antenna array. Smart antennas are classified into two groups:

- Phased array systems (switched beam forming) are defined as an array system with finite number of fixed predefined patterns.
- Adaptive Array Systems (AAS) Adaptive Beam Forming are defined as an array system with infinite number of patterns adjusted to the scenario in real time. The costs and complexity of these array systems are high compared to the Phase Array Systems.

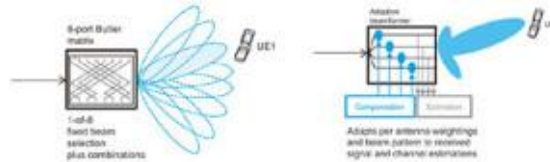

Adaptive Beam former

**Single-User MIMO (SU-MIMO):**

Single-user MIMO can be defined as increase in the data rate for a single user equipment (UE).

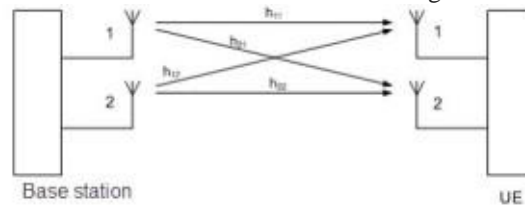

Single User MIMO

**Multi-User MIMO (MU-MIMO):**

This MIMO mode is mostly useful in the uplink based on the complexity placed on the user equipment side, and it can be kept to a minimum range by using only one antenna. This MIMO is also known as Collaborative MIMO.

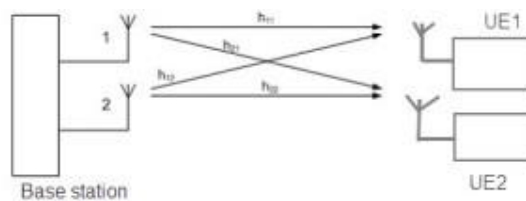

Multi User MIMO

**B. Beam forming techniques**

A beam former is used to combines the signals received by the different elements of an antenna array to form a single output. Beam forming consists of transmitting the same signal with different gain and phase over all source antennas such that the receiver signal is maximized [12].

**Taylor window beam forming**

Taylor windows are similar to Chebyshev windows. Whereas a Chebyshev window has the narrowest possible main lobe for a specified side lobe level, a Taylor window allows you to make tradeoffs between the main lobe width and the side lobe level. This distribution avoids edge discontinuities, so Taylor window side lobes decrease monotonically.

Taylor window coefficients are not normalized. Taylor windows beam forming are typically used in radar applications, such as weighting synthetic aperture radar images and antenna design.

**Adaptive Beam forming**

An adaptive beam former is a system that performs adaptive spatial signal processing with an array of transmitters or receivers.

Basically, the signals are combined in a manner which increases the signal strength to/from a chosen direction. Signals from other directions are combined in a benign or destructive manner, resulting in degradation of the signal to/from the undesired direction.

This type of technique is used in both radio frequency and acoustic arrays, and provides for directional sensitivity without physically moving an array of receivers or transmitters.

**Switched Beamforming (Phased array antenna)**

A switched-beam system is a system that can choose from one of many predefined patterns in order to enhance the received signal.

When an incoming signal is detected, the base station determines the beam that is best aligned in the signal-of-interest direction and then switches to that beam to communicate with the user.

The switched-beam, is based on a basic switching function, and selects the beam that gives the strongest received signal. The final goal of the switched-beam system is to increase the gain according to the location of the user. Hence the beams are fixed so that the intended user may not be in the center of any given main.

**IV. Simulation Using Beam Forming Result And Discussion-**

In this paper, the capacity performance of the 4\*4 MIMO systems is to be analyzed in terms of various beamforming techniques. The table shows the comparison between channel capacity and various beamforming techniques.

Channel capacity	Bartlett beam forming	Taylor window	Beam Forming With random noise	Transmit Beam forming with QAM
4.2849	4.2235	4.1949	4.2325	4.2545
5.5931	5.6587	5.6550	5.5974	5.6228
7.2525	7.3314	7.2322	7.2778	7.3219
9.1397	9.1086	9.1614	9.1322	9.1341
11.2010	11.2065	11.2383	11.1509	11.2033
13.4448	13.4222	13.4592	13.3186	13.4280
15.7789	15.7044	15.7345	15.7883	15.7533
18.1239	18.1577	18.2146	18.1280	1.07389
20.6769	20.7429	20.5920	20.7425	20.6296
23.1850	23.1924	23.1800	23.2050	23.1949

Adaptive	Zero forcing	By phased array antenna	Taylor Beam forming	Transmit beam forming	Broad band beam forming
4.2274	4.2003	4.2465	4.2134	4.2559	4.2521
5.6190	5.6425	5.6396	5.6526	5.6078	5.6426
7.2544	7.2681	7.2633	7.2893	7.2772	7.3100
9.1222	9.1840	9.1485	9.1054	9.1520	9.1462
11.2038	11.2113	11.2321	11.1720	11.1442	11.2197
13.4546	13.4685	13.3827	13.4459	13.3392	13.4669
15.6062	15.6983	15.6819	15.6484	15.7121	15.7114
18.1278	18.1604	18.1648	18.1631	18.0818	18.1756
20.6123	20.7564	20.6499	20.6712	20.6022	20.5615
23.0462	23.1172	23.1530	23.1175	23.2102	23.1826

**Shannon capacity**

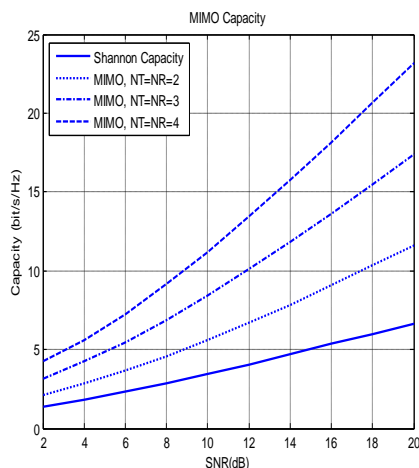

This is Shannon capacity or channel capacity of MIMO system. We compare all the beam forming techniques to this Shannon capacity. Perform this operation with the help of MATLAB.

This graph shows that when  $x=2$   $y=4.2849$  ,  $x=4$   $y=5.5931$  , $x=6$   $y=7.2525$ ,  $x=8$   $y=9.1397$ ,  $x=10$   $y=11.2010$ , $x=12$   $y=13.4448$  , $x=14$   $y=15.7789$  , $x=16$   $y=18.1239$  , $x=18$   $y=20.6769$  ,  $x=20$   $y=23.1850$  respectively.

**Bartlett beam forming**

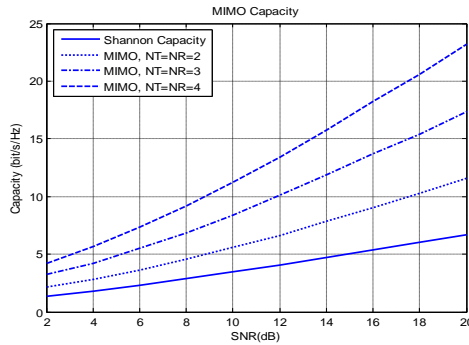

In the Shannon capacity graph the value SNR of 4 then  $y=5.5931$  and when we use\_bartlett beam forming technique then at same SNR value then  $y=5.6587$ , and also in the Shannon capacity graph the value SNR of 6  $y=7.2525$  and when we apply\_bartlett beam forming then the value SNR of 4 then  $y=7.3314$ , and in the Shannon capacity graph the value SNR of 18  $y=20.6769$  and when we use\_bartlett beam forming then the value SNR of 18  $y=20.7489$  respectively.

**Taylor window beam forming**

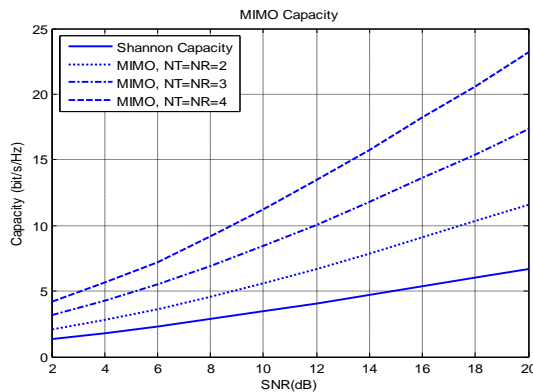

In the Shannon capacity graph the value SNR of 4 then  $y=5.5931$  and when we use\_taylor window beam forming technique then the value SNR of 4 then  $y=5.6550$ , and also in the Shannon capacity graph the value at the value SNR of 16  $y=18.1239$  and when we apply taylor window beam forming then the value at the value SNR of 16 then  $y=18$ . respectively.

**Beam forming with random noise**

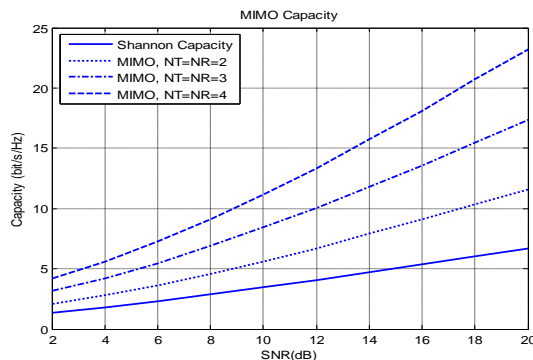

In the Shannon capacity graph the value SNR of 18 then  $y=20.6769$  and when we use beam forming with random noise technique then the value SNR of 18 then  $y=20.7425$ , and also in the Shannon capacity graph the value SNR of 20  $y=23.1850$  and when we apply beam forming with random noise technique then the value SNR of 20 then  $y=23.2050$  respectively.

**Transmit beam forming with QAM**

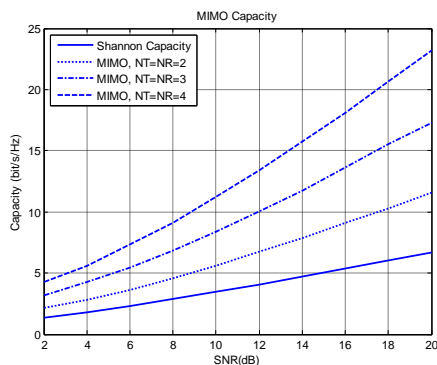

In the Shannon capacity graph the value SNR of 4 then  $y=5.5931$  and when we use transmit beam forming with QAM then the value SNR of 4 then  $y=5.6228$ , and also in the Shannon capacity graph the value SNR of 6  $y=7.2525$  and when we apply transmit beam forming with QAM then the value SNR of 6 then  $y=7.3219$  respectively.

**Adaptive beam forming**

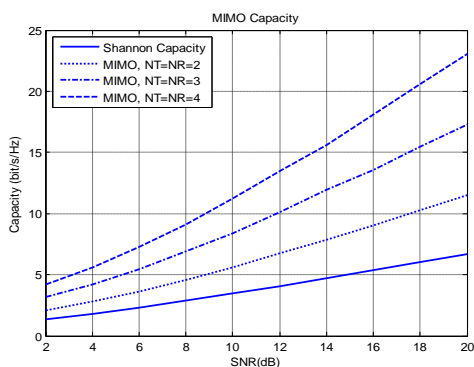

In the Shannon capacity graph the value SNR of 4 then  $y=5.5931$  and when we use adaptive beam forming then the value SNR of 4 then  $y=5.6190$  respectively.

**Zero forcing equalizer**

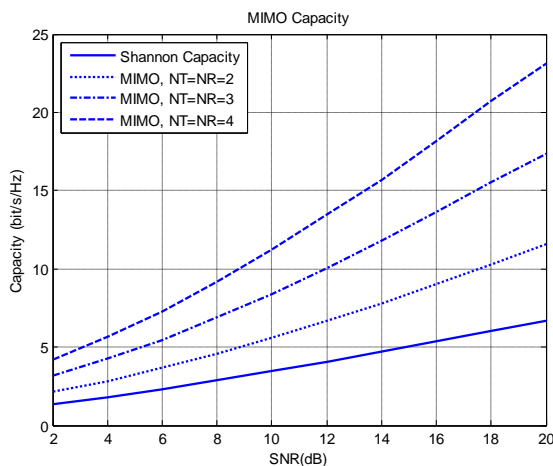



In the Shannon capacity graph the value SNR of 4 then  $y=5.5931$  and when we use Zero forcing equalizer then the value SNR of 4 then  $y=5.6425$ , and also in the Shannon capacity graph the value SNR of 18 then  $y=20.676$  and when we apply zero forcing equalizer then the value SNR of 18 then  $y=20.7564$  respectively.

**Beam forming by phased array antenna**

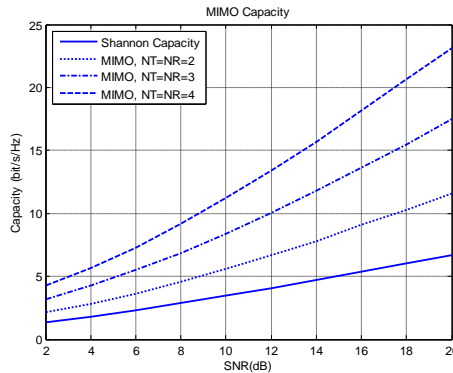

In the Shannon capacity the value SNR of 4 then  $y=5.5931$  and when we use beam forming by phased array antenna the value SNR of  $x=4$  then  $y=5.6396$ , respectively.

**Taylor beam forming**

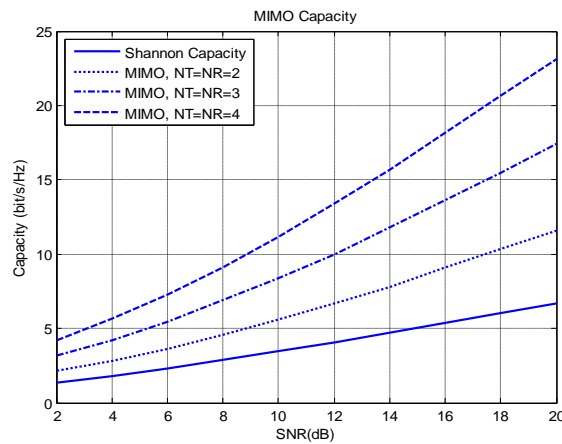

In the Shannon capacity graph the value SNR of 4 then  $y=5.5931$  and when we use taylor beam forming the value SNR of 4 then  $y=5.6526$ , respectively.

**Transmit beamforming**

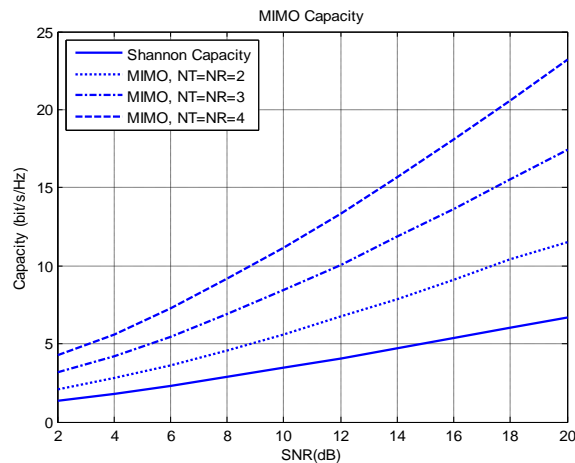

In the Shannon capacity graph the value SNR of 4 then  $y=5.5931$  and when we use transmit beamforming then the value SNR of 4 then  $y=5.6078$  and also in the Shannon capacity graph the value SNR of 20  $y=23.1850$  and when we apply transmit beamforming then at same SNR value  $y=23.2102$  respectively.

### Broadband normal beam forming

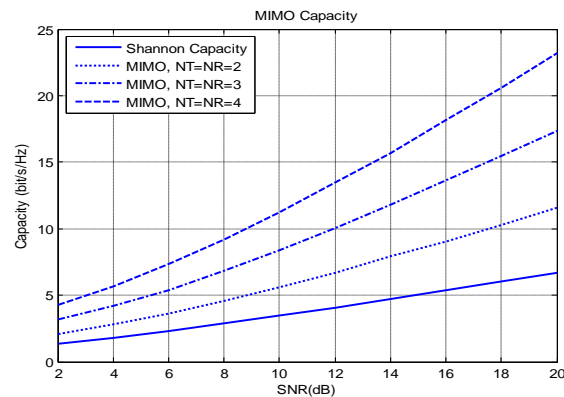

In the Shannon capacity graph the value SNR of 4 then  $y=5.5931$  and when we use broadband normal beam forming then the value SNR of 4 then  $y=5.6078$  and also in the Shannon capacity graph the value SNR of 6  $y=7.2525$  and when we apply broadband normal beam forming then at same SNR value  $y=7.3100$  respectively.

## V. Conclusion

The recent researches of MIMO technology have mainly focused on signal processing, channel modeling, and coding aspects rather than the antenna design issues. This technology can be implemented to both base station antennas and small handheld devices like mobile, laptop, Personal Digital Assistants (PDAs), etc. Implementing the multiple input multiple output technology to small portable devices is more challenging mainly due to two reasons. firstly, the antennas of the small handheld devices must have wideband characteristics to support the large data rates of the current advanced wireless systems. And secondly, when the multiple antennas are employed in small devices, mutual coupling comes into picture due to the interaction of electromagnetic waves of neighboring antennas.

In this research, we have attempted to provide a clear image of improving Channel capacity of 4\*4 MIMO system by various beamforming techniques. Results generated show the relationship between the Capacity and the Signal to noise ratio; our results show that channel capacity variations based on various beamforming techniques using MATLAB codes. Result shows that enhancing of MIMO's channel capacity for different beamforming techniques.

## Reference

- [1]. Vikram Singh#1, Amita Soni#2 (2013)"Capacity enhancement of MIMO system under different fading channels" International Journal of Scientific & Engineering Research, Volume 4, Issue 7, July-2013 ISSN 2229-5518
- [2]. Prasad Rayi1, Sarat Chandra Ch2 "Performance Evaluation of Channel Capacity In MIMO System" IJERA Vol. 1, Issue 4, pp.1871-1878.
- [3]. E. Ghayoula, A. Bouallegue, R. Ghayoula, and J-Y.Chouinard (2014) "Capacity and Performance of MIMO systems for Wireless Communications" Journal of Engineering Science and Technology Review 7 (3) (2014) 108 – 111.
- [4]. Rajesh Bansode, Prajakta Sarode, B. K. Mishra, "Design, Simulation and Performance Evaluation of 4 x 4 MIMO Transceiver System using 16 QAM" International Conference & workshop on Advanced Computing 2013 (ICWAC 2013)
- [5]. Hussain Bohra, Mahesh Kumar Porwal(2014) " Study and Analysis Capacity of MIMO Systems for AWGN Channel Model Scenarios" Journal of Engineering Research and Applications www.ijera.com ISSN: 2248-9622, Vol. 4.
- [6]. R. Scholtz, "Multiple Access with Time-Hopping Impulse Modulation," IEEE military. Commun. Conf., vol. 2, pp. 447-450, 1993.
- [7]. "Wireless communications and networks" second edition, by Theodore S. Rappaport
- [8]. B. G. Evans at all "Visions of 4G," Electronics and Communication Engineering Journal, Dec. 2002.
- [9]. P. Murphy, F. Lou, A. Sabharwal, J.P. Frantz, "An FPGA based rapid prototyping platform for MIMO systems", Proc. of Asilomar, vol. 1, pp. 900–904, Nov. 2003.
- [10]. "System requirements for IEEE 802.20 mobile broadband wireless access systems," IEEE, Draft IEEE 802.20-PD-06 version 14, July 2004.
- [11]. T. Kaiser, A. Wilzeck, M. Berentsen, and M. Rupp, "Prototyping for MIMO Systems - An Overview", in (EUSIPCO), pp. 681–688, Vienna, Austria, Sept. 2004
- [12]. Luis Miguel Cortes-Pena "MIMO Space-Time Block Coding (STBC) Simulations and Results" Design Project: Personal and Mobile Communications, Georgia Tech (Ece6604), April 2009